

## Features

- 2.4 GHz Direct Sequence Spread Spectrum (DSSS) radio transceiver
- Operates in the unlicensed worldwide Industrial, Scientific, and Medical (ISM) band (2.400 GHz to 2.483 GHz)
- 21 mA operating current (Transmit at -5 dBm)
- Transmit power up to +4 dBm
- Receive sensitivity up to -97 dBm
- Sleep Current less than 1  $\mu$ A
- DSSS data rates up to 250 kbps, GFSK data rate of 1 Mbps
- Low external component count
- Auto Transaction Sequencer (ATS) - no MCU intervention
- Framing, Length, CRC16, and Auto ACK
- Power Management Unit (PMU) for MCU/Sensor
- Fast Startup and Fast Channel Changes
- Separate 16-byte Transmit and Receive FIFOs
- AutoRate™ - dynamic data rate reception
- Receive Signal Strength Indication (RSSI)
- Serial Peripheral Interface (SPI) control while in sleep mode
- 4 MHz SPI microcontroller interface

- Battery Voltage Monitoring Circuitry
- Supports coin-cell operated applications
- Operating voltage from 1.8 V to 3.6 V
- Operating temperature from 0 °C to 70 °C
- Space saving 40-pin QFN 6 x 6 mm package

## Applications

- Wireless Keyboards and Mice
- Wireless Gamepads
- Remote Controls
- Toys
- VOIP and Wireless Headsets
- White Goods
- Consumer Electronics
- Home Automation
- Automatic Meter Readers
- Personal Health and Entertainment

## Applications Support

See [www.cypress.com](http://www.cypress.com) for development tools, reference designs, and application notes.

## Logic Block Diagram

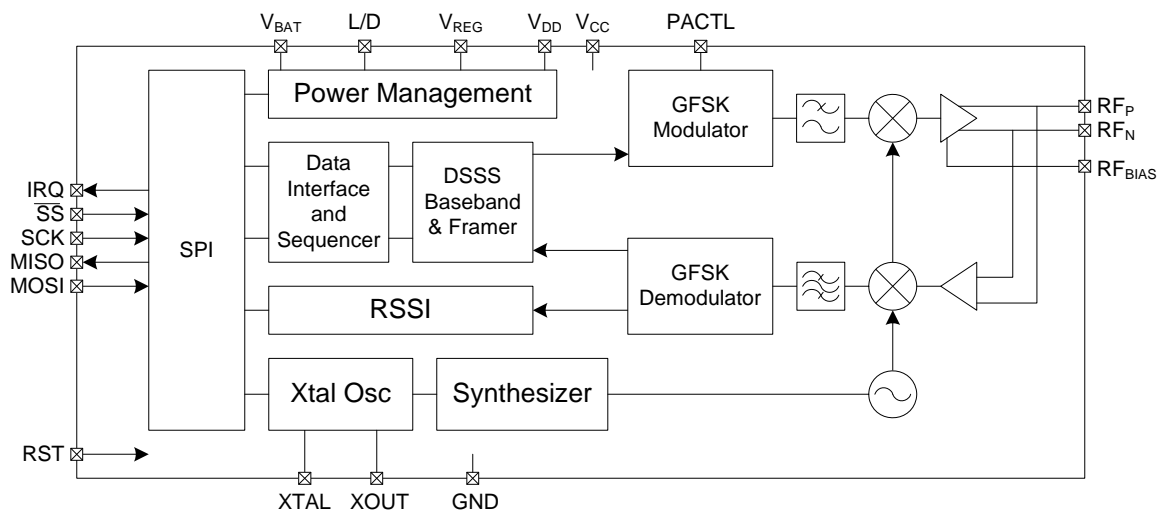

**Contents**

<b>Functional Description</b> .....	<b>3</b>	<b>Absolute Maximum Ratings</b> .....	<b>16</b>
<b>Pinouts</b> .....	<b>3</b>	<b>Operating Conditions</b> .....	<b>16</b>
<b>Pin Definitions</b> .....	<b>3</b>	<b>DC Characteristics</b> .....	<b>16</b>
<b>Functional Overview</b> .....	<b>4</b>	<b>AC Characteristics</b> .....	<b>18</b>
Data Transmission Modes .....	4	SPI Interface .....	18
Link Layer Modes .....	4	<b>RF Characteristics</b> .....	<b>19</b>
Packet Buffers .....	5	Radio Parameters .....	19
Auto Transaction Sequencer (ATS) .....	6	<b>Typical Operating Characteristics</b> .....	<b>21</b>
Data Rates .....	6	<b>AC Test Loads and Waveforms for Digital Pins</b> .....	<b>23</b>
<b>Functional Block Overview</b> .....	<b>6</b>	<b>Ordering Information</b> .....	<b>24</b>
2.4 GHz Radio .....	6	Ordering Code Definitions .....	24
Frequency Synthesizer .....	6	<b>Package Diagram</b> .....	<b>25</b>
Baseband and Framer .....	6	<b>Acronyms</b> .....	<b>27</b>
Packet Buffers and Radio Configuration Registers .....	6	<b>Document Conventions</b> .....	<b>27</b>
SPI Interface .....	6	Units of Measure .....	27
Interrupts .....	8	<b>Document History Page</b> .....	<b>28</b>
Clocks .....	8	<b>Sales, Solutions, and Legal Information</b> .....	<b>30</b>
Power Management .....	8	Worldwide Sales and Design Support .....	30
Low Noise Amplifier and		Products .....	30
Received Signal Strength Indication .....	9	PSoC® Solutions .....	30
Receive Spurious Response .....	9	Cypress Developer Community .....	30
<b>Application Examples</b> .....	<b>10</b>	Technical Support .....	30
<b>Registers</b> .....	<b>15</b>		

## Functional Description

The CYRF6936 WirelessUSB™ LP radio is a second generation member of the Cypress WirelessUSB Radio System-On-Chip (SoC) family. The CYRF6936 is interoperable with the first generation CYWUSB69xx devices. The CYRF6936 IC adds a range of enhanced features, including increased operating voltage range, reduced supply current in all operating modes, higher data rate options, reduced crystal start up, synthesizer settling, and link turnaround times.

## Pinouts

Figure 1. 40-pin QFN pinout

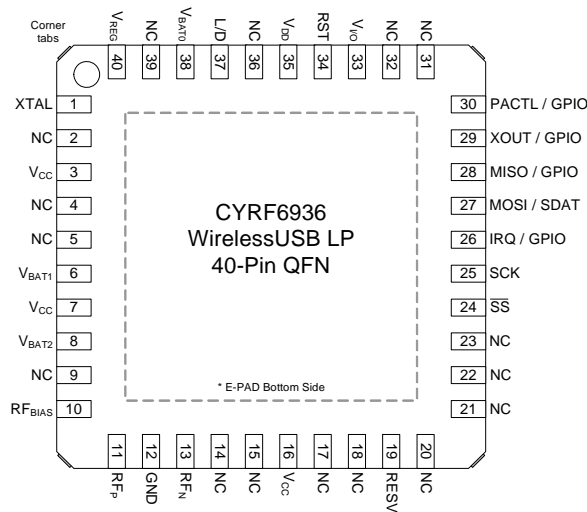

## Pin Definitions

Pin Number	Name	Type	Default	Description
1	XTAL	I	I	12 MHz crystal.
2, 4, 5, 9, 14, 15, 17, 18, 20, 21, 22, 23, 31, 32, 36, 39	NC	NC		Connect to GND.
3, 7, 16	V <sub>CC</sub>	Pwr		V <sub>CC</sub> = 2.4 V to 3.6 V. Typically connected to V <sub>REG</sub> .
6, 8, 38	V <sub>BAT(0-2)</sub>	Pwr		V <sub>BAT</sub> = 1.8 V to 3.6 V. Main supply.
10	RF <sub>BIAS</sub>	O	O	RF I/O 1.8 V reference voltage.
11	RF <sub>P</sub>	I/O	I	Differential RF signal to and from antenna.
12	GND	GND		Ground.
13	RF <sub>N</sub>	I/O	I	Differential RF signal to and from antenna.
19	RESV	I		Must be connected to GND.
24	SS	I	I	SPI enable, active LOW assertion. Enables and frames transfers.
25	SCK	I	I	SPI clock.
26	IRQ	I/O	O	Interrupt output (configurable active HIGH or LOW), or GPIO.
27	MOSI	I/O	I	SPI data input pin (Master Out Slave In), or SDAT.
28	MISO	I/O	Z	SPI data output pin (Master In Slave Out), or GPIO (in SPI 3-pin mode). Tri-states when SPI 3PIN = 0 and SS is deasserted.

**Pin Definitions** (continued)

Pin Number	Name	Type	Default	Description
29	XOUT	I/O	O	Buffered 0.75, 1.5, 3, 6, or 12 MHz clock, $\overline{\text{PACTL}}$ , or GPIO. Tri-states in sleep mode (configure as GPIO drive LOW).
30	PACTL	I/O	O	Control signal for external PA, T/R switch, or GPIO.
33	$V_{I/O}$	Pwr		I/O interface voltage, 1.8–3.6 V.
34	RST	I	I	Device reset. Internal 10 kohm pull down resistor. Active HIGH, connect through a 0.47 $\mu\text{F}$ capacitor to $V_{\text{BAT}}$ . Must have RST = 1 event the first time power is applied to the radio. Otherwise the state of the radio control registers is unknown.
35	$V_{\text{DD}}$	Pwr		Decoupling pin for 1.8 V logic regulator, connect through a 0.47 $\mu\text{F}$ capacitor to GND.
37	L/D	O		PMU inductor/diode connection, when used. If not used, connect to GND.
40	$V_{\text{REG}}$	Pwr		PMU boosted output voltage feedback.
E-PAD	GND	GND		Must be soldered to Ground.
Corner Tabs	NC	NC		Do Not solder the tabs and keep other signal traces clear. All tabs are common to the lead frame or paddle which is grounded after the pad is grounded. While they are visible to the user, they do not extend to the bottom.

**Functional Overview**

The CYRF6936 IC provides a complete WirelessUSB SPI to antenna wireless MODEMs. The SoC is designed to implement wireless device links operating in the worldwide 2.4 GHz ISM frequency band. It is intended for systems compliant with worldwide regulations covered by ETSI EN 301 489-1 V1.41, ETSI EN 300 328-1 V1.3.1 (Europe), FCC CFR 47 Part 15 (USA and Industry Canada), and TELEC ARIB\_T66\_March, 2003 (Japan).

The SoC contains a 2.4 GHz, 1 Mbps GFSK radio transceiver, packet data buffering, packet framer, DSSS baseband controller, Received Signal Strength Indication (RSSI), and SPI interface for data transfer and device configuration.

The radio supports 98 discrete 1 MHz channels (regulations may limit the use of some of these channels in certain jurisdictions).

The baseband performs DSSS spreading/despreading, Start of Packet (SOP), End of Packet (EOP) detection, and CRC16 generation and checking. The baseband may also be configured to automatically transmit Acknowledge (ACK) handshake packets whenever a valid packet is received.

When in receive mode, with packet framing enabled, the device is always ready to receive data transmitted at any of the supported bit rates. This enables the implementation of mixed-rate systems in which different devices use different data rates. This also enables the implementation of dynamic data rate systems that use high data rates at shorter distances or in a low-moderate interference environment or both. It changes to lower data rates at longer distances or in high interference environments or both.

In addition, the CYRF6936 IC has a Power Management Unit (PMU), which enables direct connection of the device to any battery voltage in the range 1.8 V to 3.6 V. The PMU conditions the battery voltage to provide the supply voltages required by the device, and may supply external devices.

**Data Transmission Modes**

The SoC supports four different data transmission modes:

- In GFSK mode, data is transmitted at 1 Mbps, without any DSSS.
- In 8DR mode, eight bits are encoded in each derived code symbol transmitted.
- In DDR mode, two bits are encoded in each derived code symbol transmitted (As in the CYWUSB6934 DDR mode).
- In SDR mode, one bit is encoded in each derived code symbol transmitted (As in the CYWUSB6934 standard modes).

Both 64 chip and 32 chip Pseudo Noise (PN) codes are supported. The four data transmission modes apply to the data after the SOP. In particular the length, data, and CRC16 are all sent in the same mode. In general, lower data rates reduce packet error rate in any given environment.

**Link Layer Modes**

The CYRF6936 IC device supports the following data packet framing features:

**SOP**

Packets begin with a two-symbol SoP marker. This is required in GFSK and 8DR modes, but is optional in DDR mode and is not supported in SDR mode. If framing is disabled then an SOP event is inferred whenever two successive correlations are detected. The SOP\_CODE\_ADR code used for the SOP is different from that used for the “body” of the packet, and if desired may be a different length. SOP must be configured to be the same length on both sides of the link.

**Length**

There are two options for detecting the end of a packet. If SOP is enabled, then the length field must be enabled. GFSK and 8DR must enable the length field. This is the first eight bits after

the SOP symbol, and is transmitted at the payload data rate. When the length field is enabled, an EoP condition is inferred after reception of the number of bytes defined in the length field, plus two bytes for the CRC16. The alternative to using the length field is to infer an EOP condition from a configurable number of successive noncorrelations; this option is not available in GFSK mode and is only recommended when using SDR mode.

**CRC16**

The device may be configured to append a 16 bit CRC16 to each packet. The CRC16 uses the USB CRC polynomial with the added programmability of the seed. If enabled, the receiver verifies the calculated CRC16 for the payload data against the received value in the CRC16 field. The seed value for the CRC16 calculation is configurable, and the CRC16 transmitted may be

calculated using either the loaded seed value or a zero seed; the received data CRC16 is checked against both the configured and zero CRC16 seeds.

CRC16 detects the following errors:

- Any one bit in error.
- Any two bits in error (irrespective of how far apart, which column, and so on).
- Any odd number of bits in error (irrespective of the location).
- An error burst as wide as the checksum itself.

Figure 2 shows an example packet with SOP, CRC16, and lengths fields enabled, and Figure 3 shows a standard ACK packet.

**Figure 2. Example Packet Format**

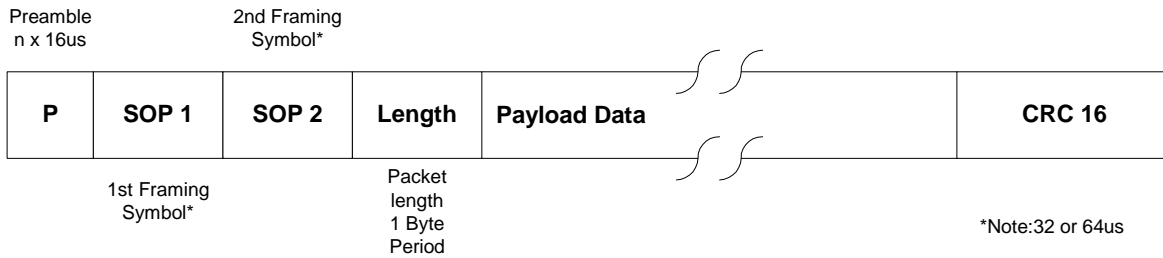

**Figure 3. Example ACK Packet Format**

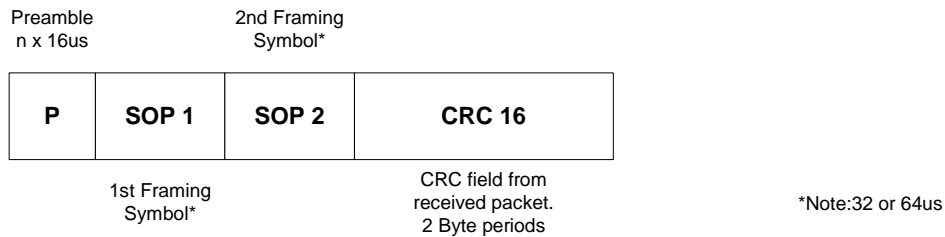

**Packet Buffers**

All data transmission and reception use the 16 byte packet buffers - one for transmission and one for reception.

The transmit buffer allows loading a complete packet of up to 16 bytes of payload data in one burst SPI transaction. This is then transmitted with no further MCU intervention. Similarly, the receive buffer allows receiving an entire packet of payload data up to 16 bytes with no firmware intervention required until the packet reception is complete.

The CYRF6936 IC supports packets up to 255 bytes. However, the actual maximum packet length depends on the accuracy of the clock on each end of the link and the data mode. Interrupts are provided to allow an MCU to use the transmit and receive buffers as FIFOs. When transmitting a packet longer than 16 bytes, the MCU can load 16 bytes initially, and add further bytes to the transmit buffer as transmission of data creates space in the buffer. Similarly, when receiving packets longer than 16 bytes, the MCU must fetch received data from the FIFO periodically during packet reception to prevent it from overflowing.

### Auto Transaction Sequencer (ATS)

The CYRF6936 IC provides automated support for transmission and reception of acknowledged data packets.

When transmitting in transaction mode, the device automatically:

- starts the crystal and synthesizer
- enters transmit mode
- transmits the packet in the transmit buffer
- transitions to receive mode and waits for an ACK packet
- transitions to the transaction end state when an ACK packet is received or a timeout period expires

Similarly, when receiving in transaction mode, the device automatically:

- waits in receive mode for a valid packet to be received
- transitions to transmit mode, transmits an ACK packet
- transitions to the transaction end state (receive mode to await the next packet, and so on.)

The contents of the packet buffers are not affected by the transmission or reception of ACK packets.

In each case, the entire packet transaction takes place without any need for MCU firmware action (as long as packets of 16 bytes or less are used). To transmit data, the MCU must load the data packet to be transmitted, set the length, and set the TX GO bit. Similarly, when receiving packets in transaction mode, firmware must retrieve the fully received packet in response to an interrupt request indicating reception of a packet.

### Data Rates

The CYRF6936 IC supports the following data rates by combining the PN code lengths and data transmission modes described in the previous sections:

- 1000 kbps (GFSK)
- 250 kbps (32 chip 8DR)
- 125 kbps (64 chip 8DR)
- 62.5 kbps (32 chip DDR)
- 31.25 kbps (64 chip DDR)
- 15.625 kbps (64 chip SDR)

## Functional Block Overview

### 2.4 GHz Radio

The radio transceiver is a dual conversion low IF architecture optimized for power, range, and robustness. The radio employs channel-matched filters to achieve high performance in the presence of interference. An integrated Power Amplifier (PA) provides up to +4 dBm transmit power, with an output power control range of 34 dB in seven steps. The supply current of the device is reduced as the RF output power is reduced.

**Table 1. Internal PA Output Power Step Table**

PA Setting	Typical Output Power (dBm)
7	+4
6	0
5	-5
4	-13
3	-18
2	-24
1	-30
0	-35

### Frequency Synthesizer

Before transmission or reception may begin, the frequency synthesizer must settle. The settling time varies depending on channel; 25 fast channels are provided with a maximum settling time of 100  $\mu$ s.

The 'fast channels' (less than 100  $\mu$ s settling time) are every third channel, starting at 0 up to and including 72 (for example, 0, 3, 6, 9 .... 69, 72).

### Baseband and Framer

The baseband and framer blocks provide the DSSS encoding and decoding, SOP generation and reception, CRC16 generation and checking, and EOP detection and length field.

### Packet Buffers and Radio Configuration Registers

Packet data and configuration registers are accessed through the SPI interface. All configuration registers are directly addressed through the address field in the SPI packet (as in the CYWUSB6934). Configuration registers allow configuration of DSSS PN codes, data rate, operating mode, interrupt masks, interrupt status, and so on.

### SPI Interface

The CYRF6936 IC has an SPI interface supporting communication between an application MCU and one or more slave devices (including the CYRF6936). The SPI interface supports single-byte and multi-byte serial transfers using either 4-pin or 3-pin interfacing. The SPI communications interface consists of Slave Select ( $\overline{SS}$ ), Serial Clock (SCK), Master Out-Slave In (MOSI), Master In-Slave Out (MISO), or Serial Data (SDAT).

SPI communication may be described as the following:

- Command Direction (bit 7) = '1' enables SPI write transaction. A '0' enables SPI read transactions.
- Command Increment (bit 6) = '1' enables SPI auto address increment. When set, the address field automatically increments at the end of each data byte in a burst access. Otherwise the same address is accessed.
- Six bits of address
- Eight bits of data

The device receives SCK from an application MCU on the SCK pin. Data from the application MCU is shifted in on the MOSI pin. Data to the application MCU is shifted out on the MISO pin. The active LOW Slave Select ( $\overline{SS}$ ) pin must be asserted to initiate an SPI transfer.

The application MCU can initiate SPI data transfers using a multi-byte transaction. The first byte is the Command/Address byte, and the following bytes are the data bytes shown in Table 2 through Figure 6 on page 8.

The SPI communications interface has a burst mechanism, where the first byte can be followed by as many data bytes as required. A burst transaction is terminated by deasserting the slave select ( $SS = 1$ ).

The SPI communications interface single read and burst read sequences are shown in Figure 4 on page 7 and Figure 5 on page 7, respectively.

The SPI communications interface single write and burst write sequences are shown in Figure 6 on page 8 and Figure 7 on page 8, respectively.

This interface may be optionally operated in a 3-pin mode with the MISO and MOSI functions combined in a single bidirectional data pin (SDAT). When using 3-pin mode, user firmware must

ensure that the MOSI pin on the MCU is in a high impedance state except when MOSI is actively transmitting data.

The device registers may be written to or read from one byte at a time, or several sequential register locations may be written or read in a single SPI transaction using incrementing burst mode. In addition to single byte configuration registers, the device includes register files. Register files are FIFOs written to and read from using nonincrementing burst SPI transactions.

The IRQ pin function may be optionally multiplexed onto the MOSI pin. When this option is enabled, the IRQ function is not available while the  $\overline{SS}$  pin is LOW. When using this configuration, user firmware must ensure that the MOSI pin on the MCU is in a high impedance state whenever the  $SS$  pin is HIGH.

The SPI interface is not dependent on the internal 12 MHz clock. Registers may therefore be read from or written to when the device is in sleep mode, and the 12 MHz oscillator disabled.

The SPI interface and the IRQ and RST pins have a separate voltage reference pin ( $V_{IO}$ ). This enables the device to interface directly to MCUs operating at voltages below the CYRF6936 IC supply voltage.

Table 2. SPI Transaction Format

Parameter	Byte 1			Byte 1+N
Bit #	7	6	[5:0]	[7:0]
Bit Name	DIR	INC	Address	Data

Figure 4. SPI Single Read Sequence

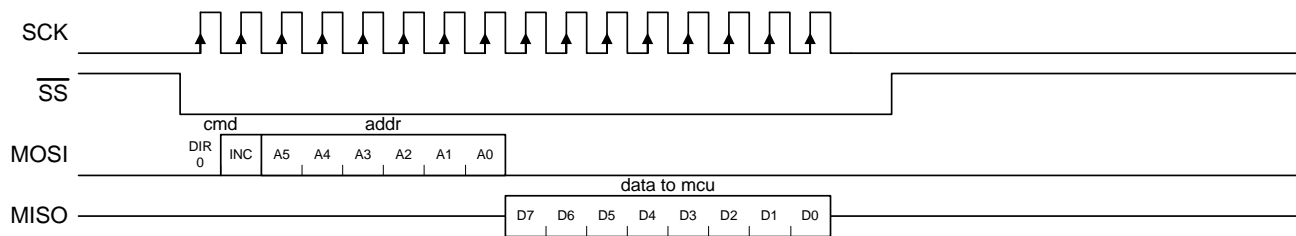

Figure 5. SPI Incrementing Burst Read Sequence

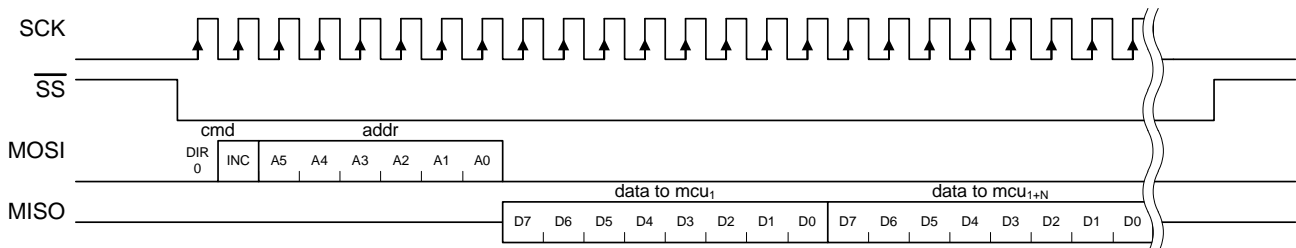

Figure 6. SPI Single Write Sequence

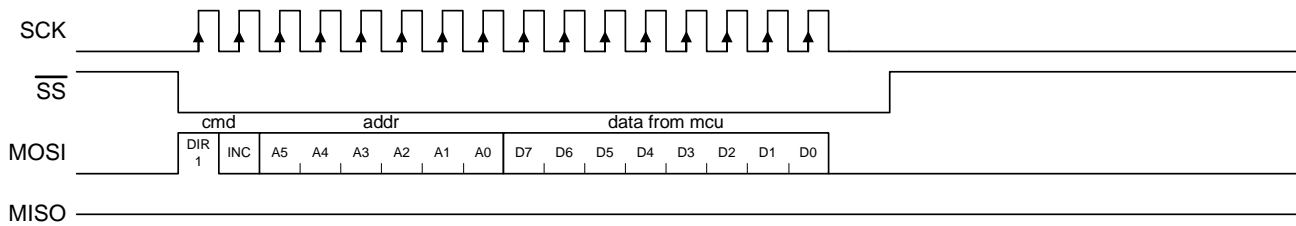
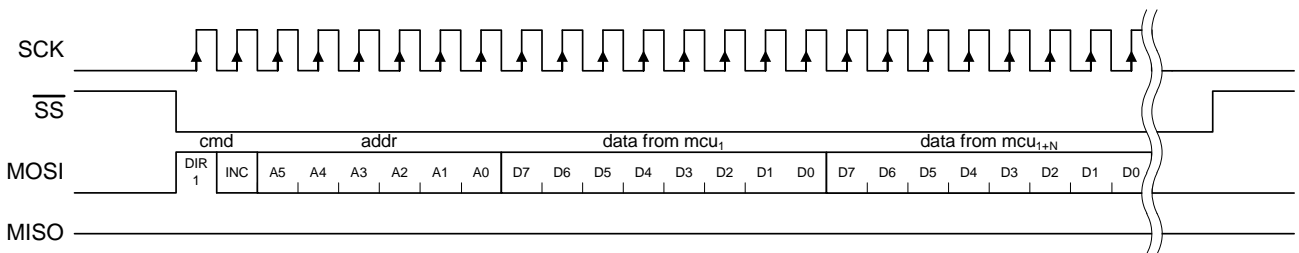

Figure 7. SPI Incrementing Burst Write Sequence



**Interrupts**

The device provides an interrupt (IRQ) output, which is configurable to indicate the occurrence of various different events. The IRQ pin may be programmed to be either active HIGH or active LOW, and be either a CMOS or open drain output. The available interrupts are described in the section [Registers on page 15](#).

The CYRF6936 IC features three sets of interrupts: transmit, receive, and system interrupts. These interrupts all share a single pin (IRQ), but can be independently enabled or disabled. The contents of the enable registers are preserved when switching between transmit and receive modes.

If more than one interrupt is enabled at any time, it is necessary to read the relevant status register to determine which event caused the IRQ pin to assert. Even when a given interrupt source is disabled, the status of the condition that would otherwise cause an interrupt can be determined by reading the appropriate status register. It is therefore possible to use the devices without the IRQ pin, by polling the status registers to wait for an event, rather than using the IRQ pin.

**Clocks**

A 12 MHz crystal (30 ppm or better) is directly connected between XTAL and GND without the need for external capacitors. A digital clock out function is provided, with selectable output frequencies of 0.75, 1.5, 3, 6, or 12 MHz. This output may be used to clock an external microcontroller (MCU) or ASIC. This output is enabled by default, but may be disabled.

The requirements to directly connect the crystal to the XTAL pin and GND are:

- Nominal Frequency: 12 MHz
- Operating Mode: Fundamental Mode
- Resonance Mode: Parallel Resonant

- Frequency Stability: ±30 ppm
- Series Resistance: ≤60 ohms
- Load Capacitance: 10 pF
- Drive Level: 100 μW

**Power Management**

The operating voltage of the device is 1.8 V to 3.6 V DC, which is applied to the V<sub>BAT</sub> pin. The device can be shut down to a fully static sleep mode by writing to the FRC END = 1 and END STATE = 000 bits in the XACT\_CFG\_ADR register over the SPI interface. The device enters sleep mode within 35 μs after the last SCK positive edge at the end of this SPI transaction. Alternatively, the device may be configured to automatically enter sleep mode after completing the packet transmission or reception. When in sleep mode, the on-chip oscillator is stopped, but the SPI interface remains functional. The device wakes from sleep mode automatically when the device is commanded to enter transmit or receive mode. When resuming from sleep mode, there is a short delay while the oscillator restarts. The device can be configured to assert the IRQ pin when the oscillator has stabilized.

The output voltage (V<sub>REG</sub>) of the Power Management Unit (PMU) is configurable to several minimum values between 2.4 V and 2.7 V. V<sub>REG</sub> may be used to provide up to 15 mA (average load) to external devices. It is possible to disable the PMU and provide an externally regulated DC supply voltage to the device's main supply in the range 2.4 V to 3.6 V. The PMU also provides a regulated 1.8 V supply to the logic.

The PMU is designed to provide high boost efficiency (74–85% depending on input voltage, output voltage, and load) when using a Schottky diode and power inductor, eliminating the need for an external boost converter in many systems where other components require a boosted voltage. However, reasonable efficiencies (69–82% depending on input voltage, output voltage,



and load) may be achieved when using low cost components such as SOT23 diodes and 0805 inductors.

The current through the diode must stay within the linear operating range of the diode. For some loads the SOT23 diode is sufficient, but with higher loads it is not and an SS12 diode must be used to stay within this linear range of operation. Along with the diode, the inductor used must not saturate its core. In higher loads, a lower resistance/higher saturation coil such as the inductor from Sumida must be used.

The PMU also provides a configurable low battery detection function, which may be read over the SPI interface. One of seven thresholds between 1.8 V and 2.7 V may be selected. The interrupt pin may be configured to assert when the voltage on the  $V_{BAT}$  pin falls below the configured threshold. LV IRQ is not a latched event. Battery monitoring is disabled when the device is in sleep mode.

### Low Noise Amplifier and Received Signal Strength Indication

The gain of the receiver can be controlled directly by clearing the AGC EN bit and writing to the Low Noise Amplifier (LNA) bit of the RX\_CFG\_ADR register. Clearing the LNA bit reduces the receiver gain approximately 20 dB, allowing accurate reception of very strong received signals (for example, when operating a receiver very close to the transmitter). Approximately 30 dB of receiver attenuation can be added by setting the Attenuation (ATT) bit. This limits data reception to devices at very short

ranges. Disabling AGC and enabling LNA is recommended, unless receiving from a device using external PA.

When the device is in receive mode the RSSI\_ADR register returns the relative signal strength of the on-channel signal power.

When receiving, the device automatically measures and stores the relative strength of the signal being received as a five bit value. An RSSI reading is taken automatically when the SoP is detected. In addition, a new RSSI reading is taken every time the previous reading is read from the RSSI\_ADR register, allowing the background RF energy level on any given channel to be easily measured when RSSI is read while no signal is being received. A new reading can occur as fast as once every 12  $\mu$ s.

### Receive Spurious Response

The transmitter may exhibit spurs around 50 MHz offset at levels approximately 50dB to 60dB below the carrier power. Receivers operating at the transmit spur frequency may receive the spur if the spur level power is greater than the receive sensitivity level.

The workaround for this is to program an additional byte in the packet header which contains the transmitter channel number. After the packet is received, the channel number can be checked. If the channel number does not match the receive channel then the packet is rejected.



Table 3. Recommended BoM for Systems where VBAT ≤ 2.4 V

Item	Qty	CY Part Number	Reference	Description	Manufacturer	Mfr Part Number
1	1	NA	ANT1	2.5 GHZ H-STUB WIGGLE ANTENNA FOR 63 MIL PCB	NA	NA
2	1	NA	BH1	BATTERY CLIPS 2AA CELL		
3	1	730-10012	C1	CAP 15 PF 50 V CERAMIC NPO 0402	Panasonic	ECJ-0EC1H150J
4	1	730-11955	C3	CAP 2.0 PF 50 V CERAMIC NPO 0402	Kemet	C0402C209C5GACTU
5	1	730-11398	C4	CAP 1.5 PF 50 V CERAMIC NPO 0402 SMD	PANASONIC	ECJ-0EC1H1R5C
6	2	730R-13322	C5, C17	CAP CER 0.47 UF 6.3 V X5R 0402	Murata	GRM155R60J474KE19D
7	2	730-13037	C12, C7	CAP CERAMIC 10 UF 6.3 V X5R 0805	Kemet	C0805C106K9PACTU
8	1	730-13400	C8	CAP 1 uF 6.3 V CERAMIC X5R 0402	Panasonic	ECJ-0EB0J105M
9	6	730-13404	C9, C10, C11, C13, C15, C16	CAP 0.047 uF 16 V CERAMIC X5R 0402	AVX	0402YD473KAT2A
10	1	710-13201	C18	CAP 100 UF 10 V ELECT FC	Panasonic - ECG	EEU-FC1A101S
11	2	730-10794	C20,C19	CAP 10000 PF 16 V CERAMIC 0402 SMD	Panasonic - ECG	ECJ-0EB1C103K
12	1	800-13317	D1	DIODE SCHOTTKY 0.5 A 40 V SOT23	DIODES INC	BAT400D-7-F
13	1	NA	J1	PCB COPPER PADS	NONE	
14	1	420-11496	J2	CONN HDR BRKWAY 5POS STR AU PCB	AMP Division of TYCO	103185-5
15	1	420-11964	J3	HEADER 1 POS 0.230 HT MODII .100 CL	AMP/Tyco	103185-1
16	1	800-13401	L1	INDUCTOR 22 NH 2% FIXED 0603 SMD	Panasonic - ECG	ELJ-RE22NGF2
17	1	800-11651	L2	INDUCTOR 1.8 NH +/- .3 NH FIXED 0402 SMD	Panasonic - ECG	ELJ-RF1N8DF
18	1	800-10594	L3	COIL 10 UH 1100MA CHOKE 0805	Newark	30K5421
19	1	630-11356	R2	RES 1.00 OHM 1/8 W 1% 0805 SMD	Yageo	9C08052A1R00FKHFT
20	1	610-13402	R3	RES 47 OHM 1/16 W 5% 0402 SMD	Panasonic - ECG	ERJ-2GEJ470X
21	1	800-13368	S1	LT SWITCH 6 MM 100 GF H = 7 MM TH	Panasonic - ECG	EVQ-PAC07K
22	1	CYRF6936-40LFC	U1	IC, LP 2.4 GHz RADIO SoC QFN-40	Cypress Semiconductor	CYRF6936 Rev A5
23	1	CY7C60123-PVXC	U2	IC WIRELESS EnCore II CONTROLLER SSOP48	Cypress Semiconductor	CY7C60123-PVXC
24	1	800-13259	Y1	CRYSTAL 12.00 MHZ HC49 SMD	eCERA	GF-1200008
25	1	PDC-9265-*B	PCB	PRINTED CIRCUIT BOARD	Cypress Semiconductor	PDC-9265-*B
26	1	920-11206	LABEL1	Serial Number		
27	1	920-26504 *A	LABEL2	PCA #		121-26504 *A

**Table 3. Recommended BoM for Systems where VBAT ≤ 2.4 V (continued)**

Item	Qty	CY Part Number	Reference	Description	Manufacturer	Mfr Part Number
No Load Components - Do Not Install						
28	1	730-13403	C6	CAP 47UF 6.3 V CERAMIC X5R 1210	Panasonic	ECJ-4YB0J476M
29	1	630-10242	R2	RES CHIP 0.0 OHM 1/10W 5% 0805 SMD	Phycomp USA Inc	9C08052A0R00JLHFT
30	1	730-13404	C7	CAP 0.047 uF 50 V CERAMIC X5R 0402	AVX	0402YD473KAT2A
31	1	420-10921	J4	HEADER 3POS FRIC STRGHT MTA 100	AMP/Tyco	644456-3
32	1	620-10519	R1	RES ZERO OHM 1/16W 5% 0603 SMD	Panasonic - ECG	ERJ-3GEY0R00V

Figure 9. Recommended Circuit for Systems where  $V_{BAT}$  is 2.4 V–3.6 V (PMU Disabled)

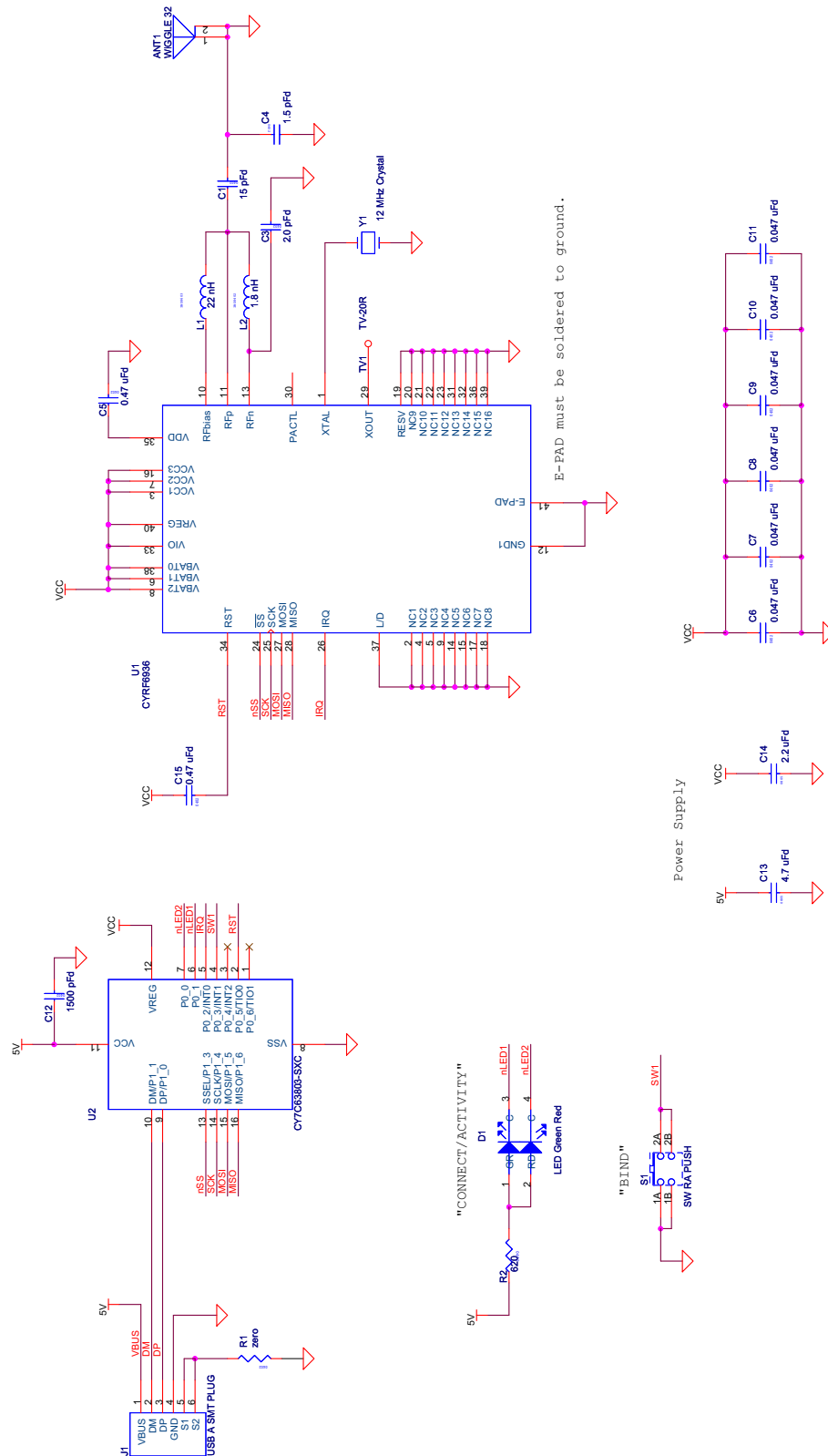

**Table 4. Recommended BoM for Systems where  $V_{BAT}$  is 2.4 V–3.6 V (PMU disabled)**

Item	Qty	CY Part Number	Reference	Description	Manufacturer	Mfr Part Number
1	1	NA	ANT1	2.5 GHZ H-STUB WIGGLE ANTENNA FOR 32MIL PCB	NA	NA
2	1	730-10012	C1	CAP 15 PF 50 V CERAMIC NPO 0402	Panasonic	ECJ-0EC1H150J
3	1	730-11955	C3	CAP 2.0 PF 50 V CERAMIC NPO 0402	Kemet	C0402C209C5GACTU
4	1	730-11398	C4	CAP 1.5 PF 50 V CERAMIC NPO 0402 SMD	PANASONIC	ECJ-0EC1H1R5C
5	1	730-13322	C5, C15	CAP 0.47 uF 6.3 V CERAMIC X5R 0402	Murata	GRM155R60J474KE19D
6						
7	6	730-13404	C6, C7, C8, C9, C10, C11	CAP 0.047 uF 16 V CERAMIC X5R 0402	AVX	0402YD473KAT2A
8	1	730-11953	C12	CAP 1500 PF 50 V CERAMIC X7R 0402	Kemet	C0402C152K5RACTU
9	1	730-13040	C13	CAP CERAMIC 4.7 UF 6.3 V XR5 0805	Kemet	C0805C475K9PACTU
10	1	730-12003	C14	CAP CER 2.2 UF 10 V 10% X7R 0805	Murata Electronics North America	GRM21BR71A225KA01L
11	1	800-13333	D1	LED GREEN/RED BICOLOR 1210 SMD	LITEON	LTST-C155KGJRKT
12	1	420-13046	J1	CONN USB PLUG TYPE A PCB SMT	ACON	UAR72-4N5J10
13	1	800-13401	L1	INDUCTOR 22NH 2% FIXED 0603 SMD	Panasonic - ECG	ELJ-RE22NGF2
14	1	800-11651	L2	INDUCTOR 1.8 NH +/- .3 NH FIXED 0402 SMD	Panasonic - ECG	ELJ-RF1N8DF
15	1	610-10343	R1	RES ZERO OHM 1/16W 0402 SMD	Panasonic - ECG	ERJ-2GE0R00X
16	1	610-13472	R2	RES CHIP 620 OHM 1/16W 5% 0402 SMD	Panasonic - ECG	ERJ-2GEJ621X
17	1	200-13471	S1	SWITCH LT 3.5 MM X 2.9 MM 160 GF SMD	Panasonic - ECG	EVQ-P7J01K
18	1	CYRF6936-40LFC	U1	IC, LP 2.4 GHz RADIO SoC QFN-40	Cypress Semiconductor	CYRF6936 Rev A5
19	1	CY7C63803-SXC	U2	IC LOW SPEED USB ENCORE II CONTROLLER SOIC16	Cypress Semiconductor	CY7C63803-SXC
20	1	800-13259	Y1	CRYSTAL 12.00 MHZ HC49 SMD	eCERA	GF-1200008
21	1	PDC-9263-*B	PCB	PRINTED CIRCUIT BOARD	Cypress Semiconductor	PDC-9263-*B
22	1		LABEL1	Serial Number	XXXXXX	
23	1		LABEL2	PCA #	121-26305 **	

## Registers

All registers are read and writable, except where noted. Registers may be written to or read from individually or in sequential groups.<sup>[1], [2]</sup>

**Table 5. Register Map Summary**

Address	Mnemonic	b7	b6	b5	b4	b3	b2	b1	b0	Default <sup>[1]</sup>	Access <sup>[1]</sup>	
0x00	CHANNEL_ADR	Not Used	Channel							-1001000	-bbbbbbb	
0x01	TX_LENGTH_ADR	TX Length									00000000	bbbbbbb
0x02	TX_CTRL_ADR	TX GO	TX CLR	TXB15 IRQEN	TXB8 IRQEN	TXB0 IRQEN	TXBERR IRQEN	TXC IRQEN	TXE IRQEN	00000011	bbbbbbb	
0x03	TX_CFG_ADR	Not Used	Not Used	DATA CODE LENGTH	DATA MODE		PA SETTING			--000101	--bbbbbb	
0x04	TX_IRQ_STATUS_ADR	OS IRQ	LV IRQ	TXB15 IRQ	TXB8 IRQ	TXB0 IRQ	TXBERR IRQ	TXC IRQ	TXE IRQ	-----	rrrrrrrr	
0x05	RX_CTRL_ADR	RX GO	RSVD	RXB16 IRQEN	RXB8 IRQEN	RXB1 IRQEN	RXBERR IRQEN	RXC IRQEN	RXE IRQEN	00000111	bbbbbbb	
0x06	RX_CFG_ADR	AGC EN	LNA	ATT	HILO	FAST TURN EN	Not Used	RXOW EN	VLD EN	10010-10	bbbbbb-bb	
0x07	RX_IRQ_STATUS_ADR	RXOW IRQ	SOPDET IRQ	RXB16 IRQ	RXB8 IRQ	RXB1 IRQ	RXBERR IRQ	RXC IRQ	RXE IRQ	-----	brrrrrrr	
0x08	RX_STATUS_ADR	RX ACK	PKT ERR	EOP ERR	CRC0	Bad CRC	RX Code	RX Data Mode		-----	rrrrrrrr	
0x09	RX_COUNT_ADR	RX Count									00000000	rrrrrrrr
0x0A	RX_LENGTH_ADR	RX Length									00000000	rrrrrrrr
0x0B <sup>[1]</sup>	PWR_CTRL_ADR	PMU EN	LVIRQ EN	PMU Mode Force	PFET disable <sup>[3]</sup>	LVI TH		PMU OUTV		10100000	bbbbbbb	
0x0C	XTAL_CTRL_ADR	XOUT FN		XSIRQ EN	Not Used	Not Used	FREQ			000-100	bbb--bbb	
0x0D	IO_CFG_ADR	IRQ OD	IRQ POL	MISO OD	XOUT OD	PACTL OD	PACTL GPIO	SPI 3PIN	IRQ GPIO	00000000	bbbbbbb	
0x0E	GPIO_CTRL_ADR	XOUT OP	MISO OP	PACTL OP	IRQ OP	XOUT IP	MISO IP	PACTL IP	IRQ IP	0000----	bbbbrrrr	
0x0F	XACT_CFG_ADR	ACK EN	Not Used	FRC END	END STATE		ACK TO			1-000000	b-bbbbb	
0x10	FRAMING_CFG_ADR	SOP EN	SOP LEN	LEN EN	SOP TH						10100101	bbbbbbb
0x11	DATA32_THOLD_ADR	Not Used	Not Used	Not Used	Not Used	TH32					---0100	---bbbb
0x12	DATA64_THOLD_ADR	Not Used	Not Used	Not Used	TH64					---01010	---bbbb	
0x13	RSSI_ADR	SOP	Not Used	LNA	RSSI					0-100000	r-rrrrrr	
0x14	EOP_CTRL_ADR <sup>[4]</sup>	HEN	HINT			EOP					10100100	bbbbbbb
0x15	CRC_SEED_LSB_ADR	CRC SEED LSB									00000000	bbbbbbb
0x16	CRC_SEED_MSB_ADR	CRC SEED MSB									00000000	bbbbbbb
0x17	TX_CRC_LSB_ADR	CRC LSB									-----	rrrrrrrr
0x18	TX_CRC_MSB_ADR	CRC MSB									-----	rrrrrrrr
0x19	RX_CRC_LSB_ADR	CRC LSB									11111111	rrrrrrrr
0x1A	RX_CRC_MSB_ADR	CRC MSB									11111111	rrrrrrrr
0x1B	TX_OFFSET_LSB_ADR	STRIM LSB									00000000	bbbbbbb
0x1C	TX_OFFSET_MSB_ADR	Not Used	Not Used	Not Used	Not Used	STRIM MSB					---0000	---bbbb
0x1D	MODE_OVERRIDE_ADR	RSVD	RSVD	FRC SEN	FRC AWAKE		Not Used	Not Used	RST	00000-0	wwwww--w	
0x1E	RX_OVERRIDE_ADR	ACK RX	RXTX DLY	MAN RXACK	FRC RXDR	DIS CRC0	DIS RXCRC	ACE	Not Used	0000000-	bbbbbbb-	
0x1F	TX_OVERRIDE_ADR	ACK TX	FRC PRE	RSVD	MAN TXACK	OVRD ACK	DIS TXCRC	RSVD	TX INV	00000000	bbbbbbb	
0x26	XTAL_CFG_ADR	RSVD	RSVD	RSVD	RSVD	START DLY	RSVD	RSVD	RSVD	00000000	wwwwwwww	
0x27	CLK_OVERRIDE_ADR	RSVD	RSVD	RSVD	RSVD	RSVD	RSVD	RXF	RSVD	00000000	wwwwwwww	
0x28	CLK_EN_ADR	RSVD	RSVD	RSVD	RSVD	RSVD	RSVD	RXF	RSVD	00000000	wwwwwwww	
0x29	RX_ABORT_ADR	RSVD	RSVD	ABORT EN	RSVD	RSVD	RSVD	RSVD	RSVD	00000000	wwwwwwww	
0x32	AUTO_CAL_TIME_ADR	AUTO_CAL_TIME									00000011	wwwwwwww
0x35	AUTO_CAL_OFFSET_ADR	AUTO_CAL_OFFSET									00000000	wwwwwwww
0x39	ANALOG_CTRL_ADR	RSVD	RSVD	RSVD	RSVD	RSVD	RSVD	RX INV	ALL SLOW	00000000	wwwwwwww	
Register Files												
0x20	TX_BUFFER_ADR	TX Buffer File									-----	wwwwwwww
0x21	RX_BUFFER_ADR	RX Buffer File									-----	rrrrrrrr
0x22	SOP_CODE_ADR	SOP Code File									Note 5	bbbbbbb
0x23	DATA_CODE_ADR	Data Code File									Note 6	bbbbbbb
0x24	PREAMBLE_ADR	Preamble File									Note 7	bbbbbbb
0x25	MFG_ID_ADR	MFG ID File									NA	rrrrrrrr

**Notes**

- b = read/write; r = read only; w = write only; '-' = not used, default value is undefined.
- Registers must be configured or accessed only when the radio is in IDLE or SLEEP mode. The PMU, GPIOs, and RSSI registers can be accessed in Active Tx and Rx mode.
- PFET Bit: Setting this bit to "1" disables the FET, therefore safely allowing Vbat to be connected to a separate reference from Vcc when the PMU is disabled to the radio.
- EOP\_CTRL\_ADR[6:4] must never have the value of "000", that is, EOP Hint Symbol count must never be "0"
- SOP\_CODE\_ADR default = 0x17FF9E213690C782.
- DATA\_CODE\_ADR default = 0x02F9939702FA5CE3012BF1DB0132BE6F.
- PREAMBLE\_ADR default = 0x333302. The count value must be greater than 4 for DDR and greater than 8 for SDR.

### Absolute Maximum Ratings

Exceeding maximum ratings may shorten the useful life of the device. User guidelines are not tested.

- Storage Temperature ..... -65 °C to +150 °C
- Ambient Temperature with Power Applied ..... -55 °C to +125 °C
- Supply Voltage on any power supply pin relative to  $V_{SS}$  ..... -0.3 V to +3.9 V
- DC Voltage to Logic Inputs <sup>[8]</sup> ..... -0.3 V to  $V_{IO}$  +0.3 V
- DC Voltage applied to Outputs in High-Z State ..... -0.3 V to  $V_{IO}$  +0.3 V

- Static Discharge Voltage (Digital) <sup>[9]</sup> ..... >2000 V
- Static Discharge Voltage (RF) <sup>[9]</sup> ..... 1100 V
- Latch Up Current ..... +200 mA, -200 mA

### Operating Conditions

- $V_{CC}$  ..... 2.4 V to 3.6 V
- $V_{IO}$  ..... 1.8 V to 3.6 V
- $V_{BAT}$  ..... 1.8 V to 3.6 V
- $T_A$  (Ambient Temperature Under Bias) ..... 0 °C to +70 °C
- Ground Voltage ..... 0 V
- $F_{OSC}$  (Crystal Frequency) ..... 12 MHz  $\pm$  30 ppm

### DC Characteristics

( $T = 25^\circ\text{C}$ ,  $V_{BAT} = 2.4\text{ V}$ , PMU disabled,  $f_{OSC} = 12.000000\text{ MHz}$ )

Parameter	Description	Conditions	Min	Typ	Max	Unit
$V_{BAT}$	Battery Voltage	0 °C–70 °C	1.8	–	3.6	V
$V_{REG}^{[10]}$	PMU Output Voltage	2.4 V mode	2.4	2.43	–	V
$V_{REG}^{[10]}$	PMU Output Voltage	2.7 V mode	2.7	2.73	–	V
$V_{IO}^{[11]}$	$V_{IO}$ Voltage		1.8	–	3.6	V
$V_{CC}$	$V_{CC}$ Voltage	0 °C–70 °C	2.4 <sup>[12]</sup>	–	3.6	V
$V_{OH1}$	Output High Voltage Condition 1	At $I_{OH} = -100.0\ \mu\text{A}$	$V_{IO} - 0.2$	$V_{IO}$	–	V
$V_{OH2}$	Output High Voltage Condition 2	At $I_{OH} = -2.0\ \text{mA}$	$V_{IO} - 0.4$	$V_{IO}$	–	V
$V_{OL}$	Output Low Voltage	At $I_{OL} = 2.0\ \text{mA}$	–	0	0.45	V
$V_{IH}$	Input High Voltage		$0.7 V_{IO}$	–	$V_{IO}$	V
$V_{IL}$	Input Low Voltage		0	–	$0.3 V_{IO}$	V
$I_{IL}$	Input Leakage Current	$0 < V_{IN} < V_{IO}$	–1	0.26	+1	$\mu\text{A}$
$C_{IN}$	Pin Input Capacitance	except XTAL, $RF_N$ , $RF_P$ , $RF_{BIAS}$	–	3.5	10	pF
$I_{CC}(\text{GFSK})^{[13]}$	Average TX $I_{CC}$ , 1 Mbps, slow channel	PA = 5, 2 way, 4 bytes/10 ms	–	0.87	–	mA
$I_{CC}(32\text{-8DR})^{[13]}$	Average TX $I_{CC}$ , 250 kbps, fast channel	PA = 5, 2 way, 4 bytes/10 ms	–	1.2	–	mA
$I_{SB}^{[14]}$	Sleep Mode $I_{CC}$		–	0.8	10	$\mu\text{A}$
$I_{SB}^{[14]}$	Sleep Mode $I_{CC}$	PMU enabled	–	31.4	–	$\mu\text{A}$
IDLE $I_{CC}$	Radio off, XTAL Active	XOUT disabled	–	1.0	–	mA

**Notes**

8. It is permissible to connect voltages above  $V_{IO}$  to inputs through a series resistor limiting input current to 1 mA. AC timing not guaranteed.
9. Human Body Model (HBM).
10.  $V_{REG}$  depends on battery input voltage.
11. In sleep mode, the I/O interface voltage reference is  $V_{BAT}$ .
12. In sleep mode,  $V_{CC}$  min. can be as low as 1.8 V.
13. Includes current drawn while starting crystal, starting synthesizer, transmitting packet (including SOP and CRC16), changing to receive mode, and receiving ACK handshake. Device is in sleep except during this transaction.
14. ISB is not guaranteed if any I/O pin is connected to voltages higher than  $V_{IO}$ .



**DC Characteristics** (continued)

 (T = 25°C, V<sub>BAT</sub> = 2.4 V, PMU disabled, f<sub>OSC</sub> = 12.000000 MHz)

Parameter	Description	Conditions	Min	Typ	Max	Unit
I <sub>synth</sub>	I <sub>CC</sub> during Synth Start		–	8.4	–	mA
TX I <sub>CC</sub>	I <sub>CC</sub> during Transmit	PA = 5 (–5 dBm)	–	20.8	–	mA
TX I <sub>CC</sub>	I <sub>CC</sub> during Transmit	PA = 6 (0 dBm)	–	26.2	–	mA
TX I <sub>CC</sub>	I <sub>CC</sub> during Transmit	PA = 7 (+4 dBm)	–	34.1	–	mA
RX I <sub>CC</sub>	I <sub>CC</sub> during Receive	LNA off, ATT on	–	18.4	–	mA
RX I <sub>CC</sub>	I <sub>CC</sub> during Receive	LNA on, ATT off	–	21.2	–	mA
Boost Eff	PMU Boost Converter Efficiency	V <sub>BAT</sub> = 2.5 V, V <sub>REG</sub> = 2.73 V, I <sub>LOAD</sub> = 20 mA	–	81	–	%
I <sub>LOAD_EXT</sub> <sup>[8]</sup>	Average PMU External Load current	V <sub>BAT</sub> = 1.8 V, V <sub>REG</sub> = 2.73 V, 0 °C–50 °C, RX Mode	–	–	15	mA
I <sub>LOAD_EXT</sub> <sup>[8]</sup>	Average PMU External Load current	V <sub>BAT</sub> = 1.8 V, V <sub>REG</sub> = 2.73 V, 50 °C–70 °C, RX Mode	–	–	10	mA

**Note**

8. I<sub>LOAD\_EXT</sub> is dependent on external components and this entry applies when the components connected to L/D are SS12 series diode and DH53100LC inductor from Sumida.

## AC Characteristics

### SPI Interface

Parameter <sup>[9, 10]</sup>	Description	Min	Typ	Max	Unit
$t_{SCK\_CYC}$	SPI Clock Period	238.1	–	–	ns
$t_{SCK\_HI}$	SPI Clock High Time	100	–	–	ns
$t_{SCK\_LO}$	SPI Clock Low Time	100	–	–	ns
$t_{DAT\_SU}$	SPI Input Data Setup Time	25	–	–	ns
$t_{DAT\_HLD}$	SPI Input Data Hold Time	10	–	–	ns
$t_{DAT\_VAL}$	SPI Output Data Valid Time	0	–	50	ns
$t_{DAT\_VAL\_TRI}$	SPI Output Data Tri-state (MOSI from Slave Select Deassert)	–	–	20	ns
$t_{SS\_SU}$	SPI Slave Select Setup Time before first positive edge of SCK <sup>[11]</sup>	10	–	–	ns
$t_{SS\_HLD}$	SPI Slave Select Hold Time after last negative edge of SCK	10	–	–	ns
$t_{SS\_PW}$	SPI Slave Select Minimum Pulse Width	20	–	–	ns
$t_{SCK\_SU}$	SPI Slave Select Setup Time	10	–	–	ns
$t_{SCK\_HLD}$	SPI SCK Hold Time	10	–	–	ns
$t_{RESET}$	Minimum RST Pin Pulse Width	10	–	–	ns

Figure 10. SPI Timing

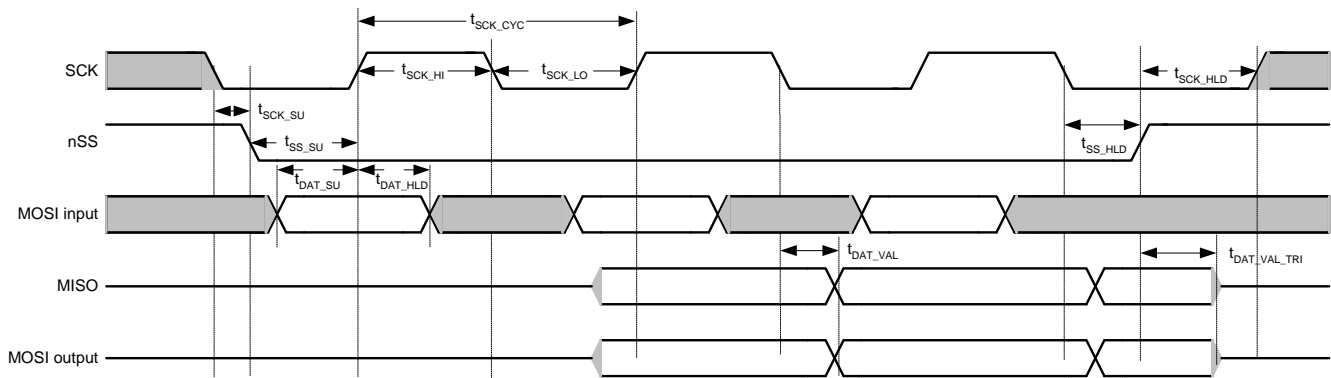

**Notes**

- 9. AC values are not guaranteed if voltage on any pin exceeding  $V_{IO}$ .
- 10.  $C_{LOAD} = 30$  pF
- 11. SCK must start low at the time  $\overline{SS}$  goes LOW, otherwise the success of SPI transactions are not guaranteed.

## RF Characteristics

### Radio Parameters

Parameter Description	Conditions	Min	Typ	Max	Unit
RF Frequency Range	Note 12	2.400	–	2.497	GHz
<b>Receiver</b> (T = 25°C, V <sub>CC</sub> = V <sub>BAT</sub> = 3.0 V, f <sub>OSC</sub> = 12.000000 MHz, BER < 1E-3)					
Sensitivity 125 kbps 64-8DR	BER 1E-3	–	–97	–	dBm
Sensitivity 250 kbps 32-8DR	BER 1E-3	–	–93	–	dBm
Sensitivity	CER 1E-3	–80	–87	–	dBm
Sensitivity GFSK	BER 1E-3, ALL SLOW = 1	–	–84	–	dBm
LNA Gain		–	22.8	–	dB
ATT Gain		–	–31.7	–	dB
Maximum Received Signal	LNA On	–15	–6	–	dBm
RSSI Value for PWR <sub>in</sub> –60 dBm [13]	LNA On	–	21	–	Count
RSSI Slope		–	1.9	–	dB/Count
<b>Interference Performance</b> (CER 1E-3)					
Co-channel Interference rejection Carrier-to-Interference (C/I)	C = –60 dBm	–	9	–	dB
Adjacent (±1 MHz) channel selectivity C/I 1 MHz	C = –60 dBm	–	3	–	dB
Adjacent (±2 MHz) channel selectivity C/I 2 MHz	C = –60 dBm	–	–30	–	dB
Adjacent (≥ 3 MHz) channel selectivity C/I ≥ 3 MHz	C = –67 dBm	–	–38	–	dB
Out-of-Band Blocking 30 MHz–12.75 MHz [14]	C = –67 dBm	–	–30	–	dBm
Intermodulation	C = –64 dBm, Δf = 5, 10 MHz	–	–36	–	dBm
<b>Receive Spurious Emission</b>					
800 MHz	100 kHz ResBW	–	–79	–	dBm
1.6 GHz	100 kHz ResBW	–	–71	–	dBm
3.2 GHz	100 kHz ResBW	–	–65	–	dBm

#### Notes

12. Subject to regulation.
13. RSSI value is not guaranteed. Extensive variation from part to part.
14. Exceptions F/3 & 5C/3.

**Radio Parameters** (continued)

Parameter Description	Conditions	Min	Typ	Max	Unit
<b>Transmitter</b> (T = 25°C, V <sub>CC</sub> = 3.0 V)					
Maximum RF Transmit Power	PA = 7	+2	4	+6	dBm
Maximum RF Transmit Power	PA = 6	-2	0	+2	dBm
Maximum RF Transmit Power	PA = 5	-7	-5	-3	dBm
Maximum RF Transmit Power	PA = 0	-	-35	-	dBm
RF Power Control Range		-	39	-	dB
RF Power Range Control Step Size	Seven steps, monotonic	-	5.6	-	dB
Frequency Deviation Min	PN Code Pattern 10101010	-	270	-	kHz
Frequency Deviation Max	PN Code Pattern 11110000	-	323	-	kHz
Error Vector Magnitude (FSK error)	>0 dBm	-	10	-	%rms
Occupied Bandwidth	-6 dBc, 100 kHz ResBW	500	876	-	kHz
<b>Transmit Spurious Emission</b> (PA = 7)					
In-band Spurious Second Channel Power (±2 MHz)		-	-38	-	dBm
In-band Spurious Third Channel Power (≥3 MHz)		-	-44	-	dBm
Non-Harmonically Related Spurs (800 MHz)		-	-38	-	dBm
Non-Harmonically Related Spurs (1.6 GHz)		-	-34	-	dBm
Non-Harmonically Related Spurs (3.2 GHz)		-	-47	-	dBm
Harmonic Spurs (Second Harmonic)		-	-43	-	dBm
Harmonic Spurs (Third Harmonic)		-	-48	-	dBm
Fourth and Greater Harmonics		-	-59	-	dBm
<b>Power Management</b> (Crystal PN# eCERA GF-1200008)					
Crystal Start to 10ppm		-	0.7	1.3	ms
Crystal Start to IRQ	XSIRQ EN = 1	-	0.6	-	ms
Synth Settle	Slow channels	-	-	270	µs
Synth Settle	Medium channels	-	-	180	µs
Synth Settle	Fast channels	-	-	100	µs
Link Turnaround Time	GFSK	-	-	30	µs
Link Turnaround Time	250 kbps	-	-	62	µs
Link Turnaround Time	125 kbps	-	-	94	µs
Link Turnaround Time	<125 kbps	-	-	31	µs
Max Packet Length	<60 ppm crystal-to-crystal all modes except 64-DDR and 64-SDR	-	-	40	bytes
Max Packet Length	<60 ppm crystal-to-crystal 64-DDR and 64-SDR	-	-	16	bytes

Typical Operating Characteristics

Figure 11. Typical Operating Characteristics [15]

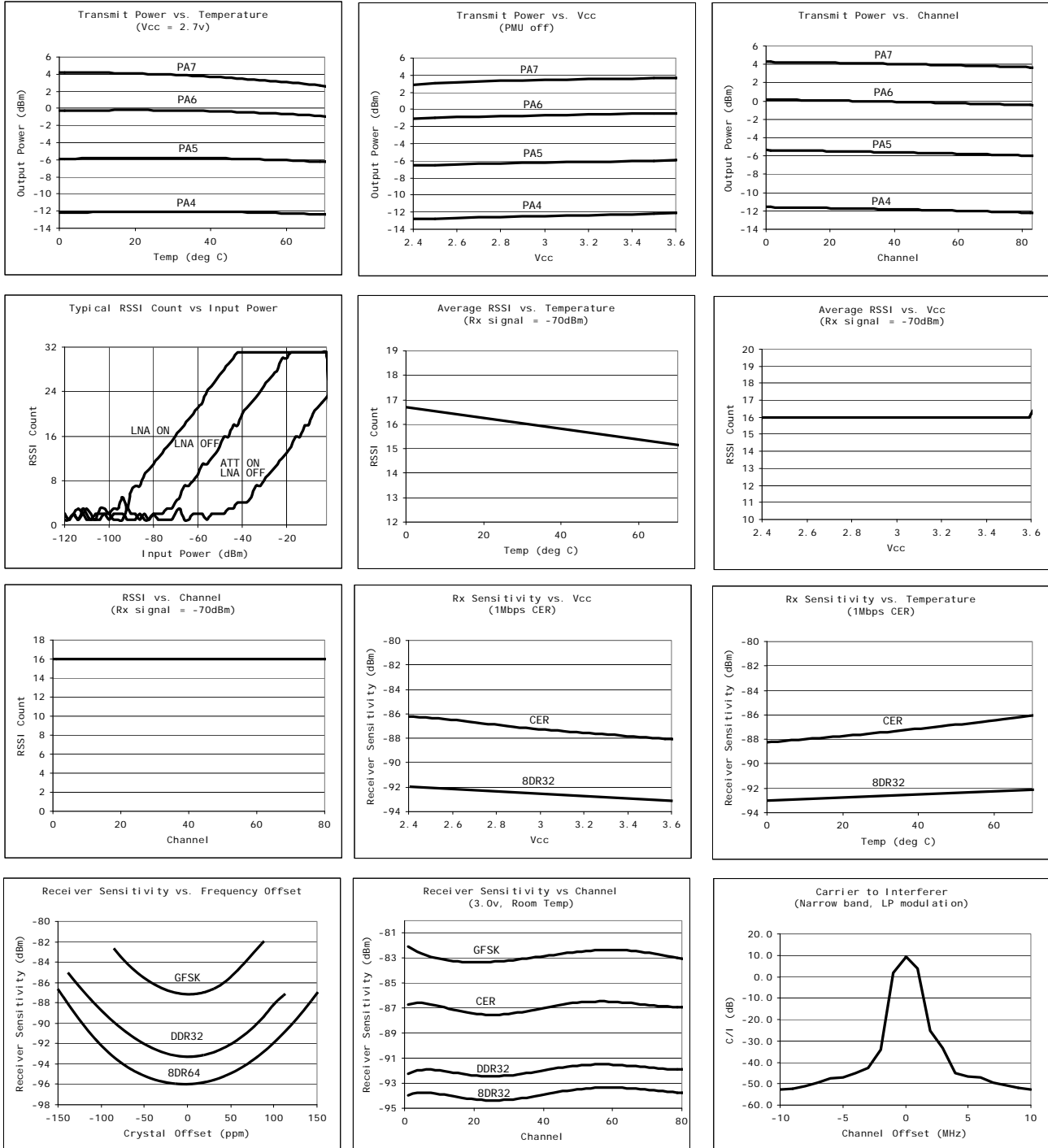

Note

15. With LNA on, ATT off, above -2dBm erroneous RSSI values may be read. Cross-checking RSSI with LNA off/on is recommended for accurate readings.

Typical Operating Characteristics (continued)

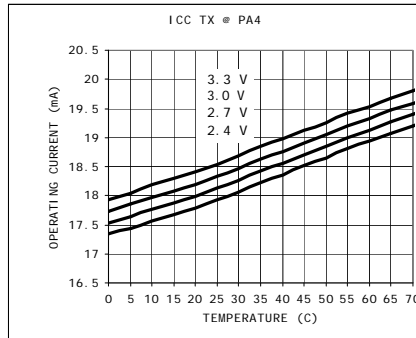
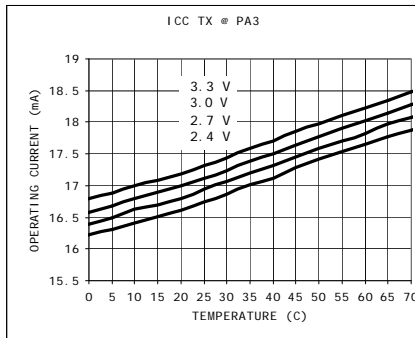
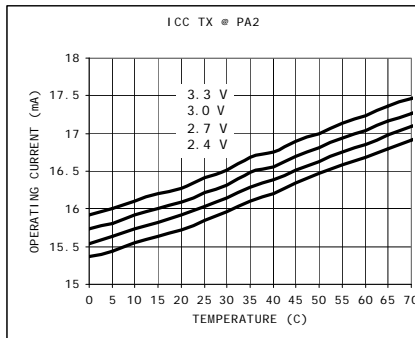
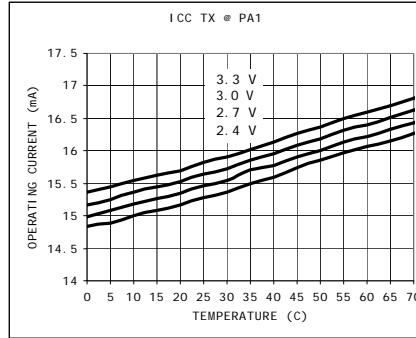
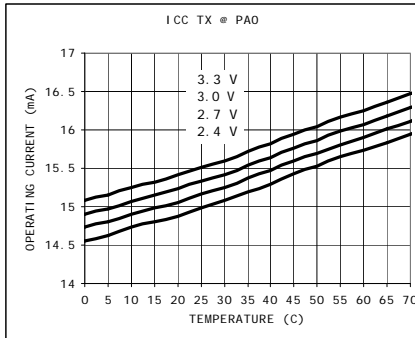
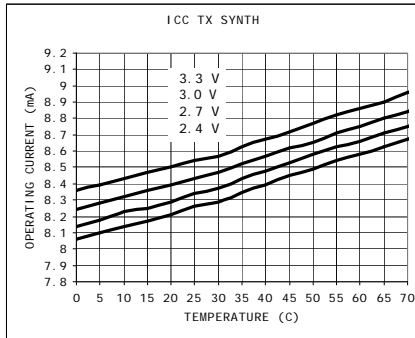
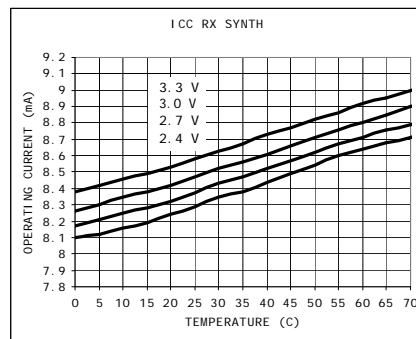
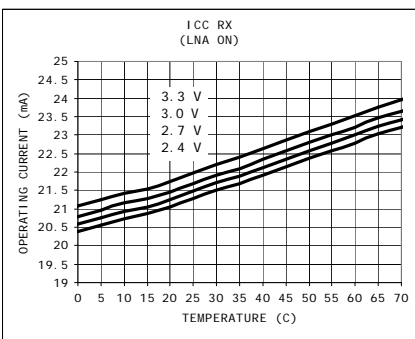
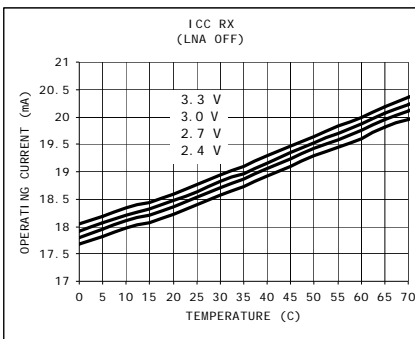
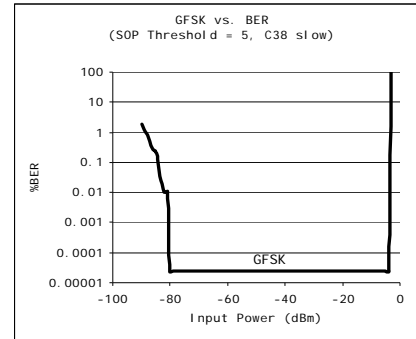
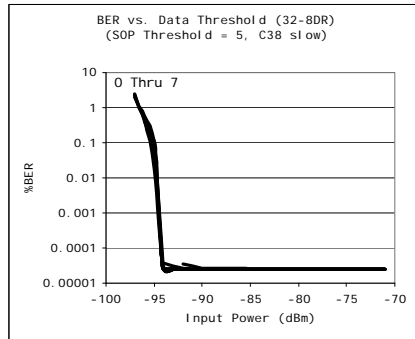
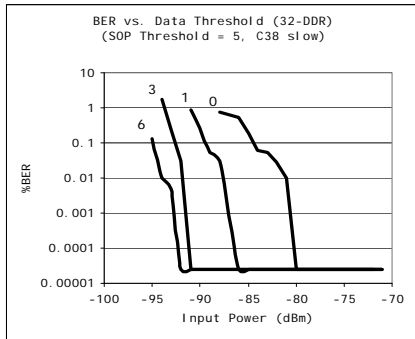

Typical Operating Characteristics (continued)

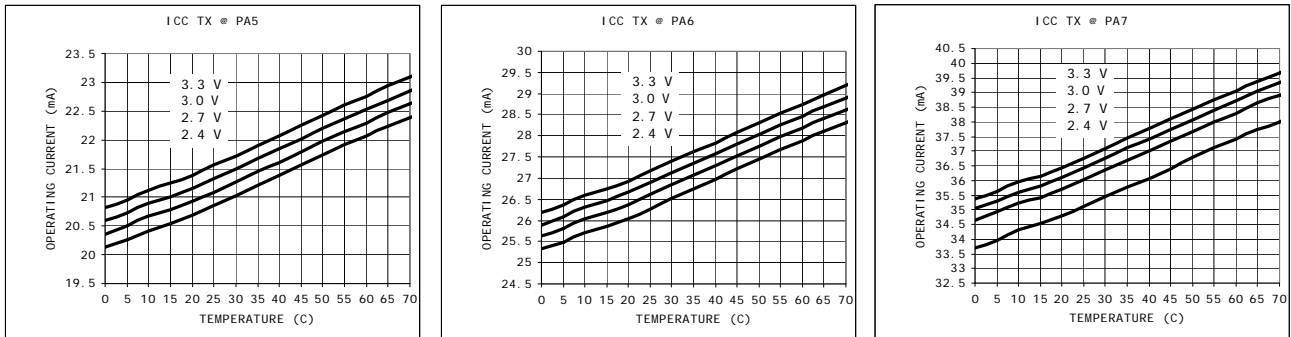

AC Test Loads and Waveforms for Digital Pins

Figure 12. AC Test Loads and Waveforms for Digital Pins

AC Test Loads

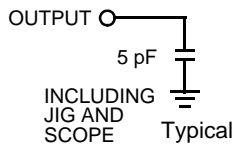
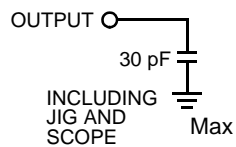

DC Test Load

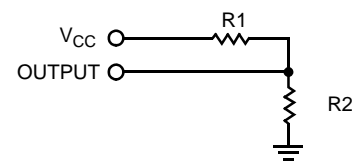

Parameter		Unit
R1	1071	$\Omega$
R2	937	$\Omega$
R <sub>TH</sub>	500	$\Omega$
V <sub>TH</sub>	1.4	V
V <sub>CC</sub>	3.00	V

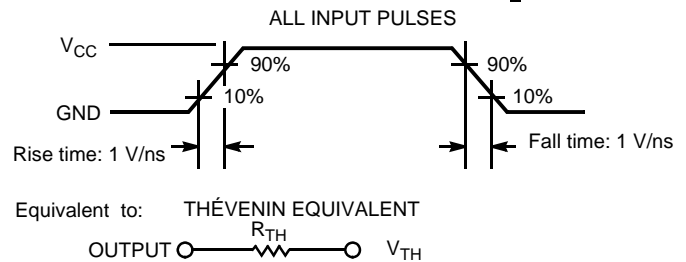

**Ordering Information**

Part Number	Radio	Package Name	Package Type	Operating Range
CYRF6936-40LFXC	Transceiver	40-pin QFN	40-pin QFN (Pb-free)	Commercial
CYRF6936-40LTXC	Transceiver	40-pin QFN	40-pin QFN (Sawn type)	Commercial

**Ordering Code Definitions**

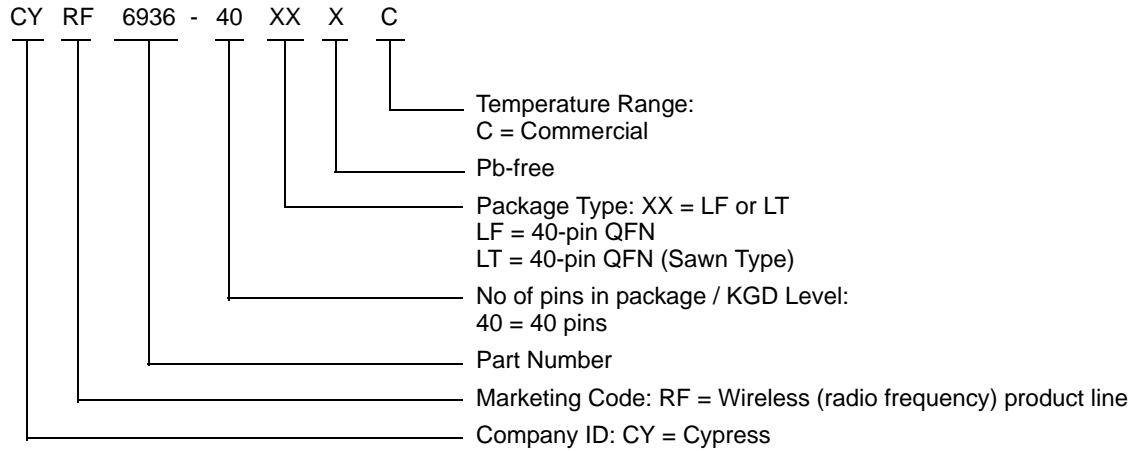





### Package Diagram

The recommended dimension of the PCB pad size for the E-PAD underneath the QFN is 3.5 mm x 3.5 mm (width x length).

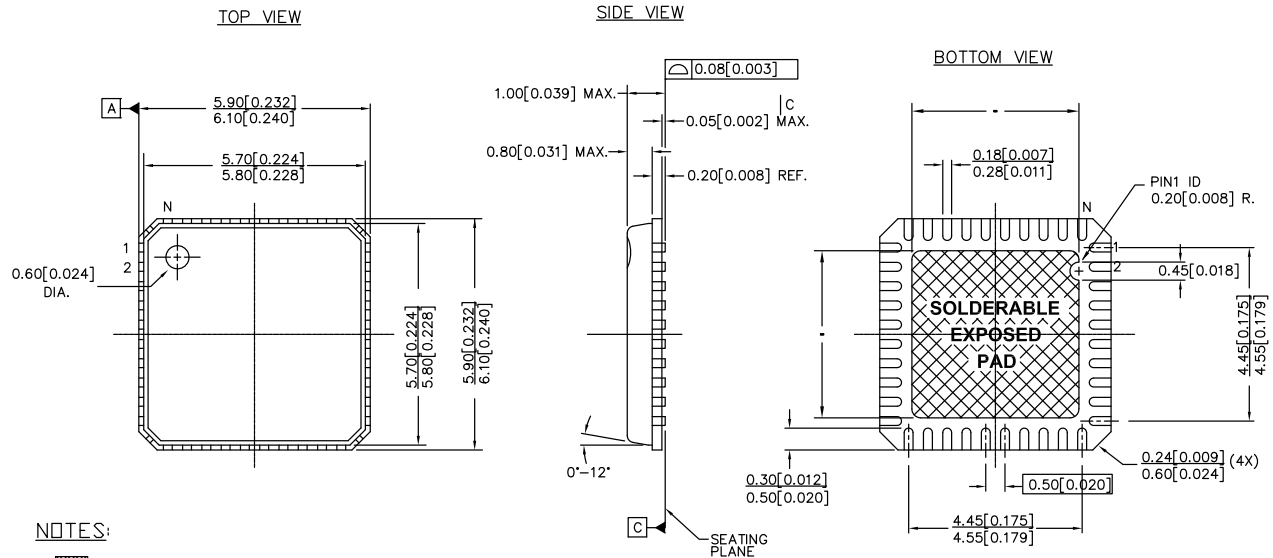
**Figure 13. 40-pin QFN (6 × 6 × 1.0 mm) 3.5 × 3.5 E-Pad (Subcon Punch Type Package) Package Outline, 001-12917**



**NOTES:**

1.  HATCH IS SOLDERABLE EXPOSED AREA
2. REFERENCE JEDEC#: MO-220
3. PACKAGE WEIGHT: 0.086g
4. ALL DIMENSIONS ARE IN MM [MIN/MAX]
5. PACKAGE CODE

PART #	DESCRIPTION
LF40A	STANDARD
LY40A	PB-FREE

001-12917 \*D

**Package Diagram** (continued)

The recommended dimension of the PCB pad size for the E-PAD underneath the QFN is 3.5 mm x 3.5 mm (width x length).

**Figure 14. 40-pin QFN (6 x 6 x 0.90 mm) 3.5 x 3.5 E-Pad (Sawn) Package Outline, 001-44328**

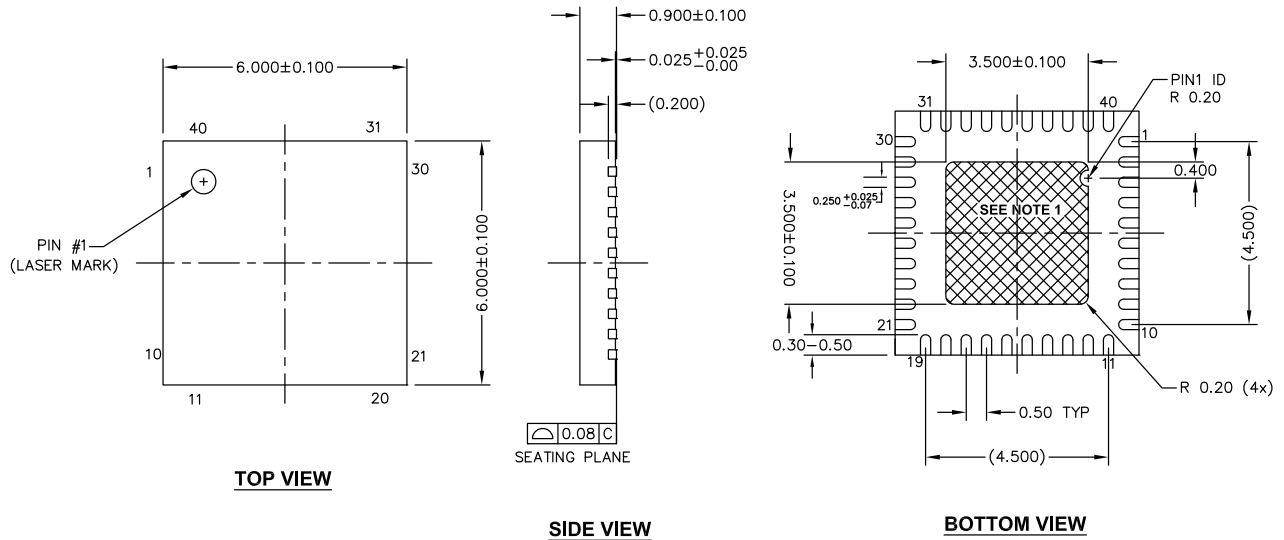

**NOTES:**

1.  HATCH IS SOLDERABLE EXPOSED AREA.
2. REFERENCE JEDEC # MO-220
3. PACKAGE WEIGHT: 0.086g
4. ALL DIMENSIONS ARE IN MILLIMETERS

001-44328 \*F

## Acronyms

Table 6. Acronyms Used in this Document

Acronym	Description
ACK	Acknowledge (packet received, no errors)
BER	Bit Error Rate
BOM	Bill Of Materials
CMOS	Complementary Metal Oxide Semiconductor
CRC	Cyclic Redundancy Check
GFSK	Gaussian Frequency-Shift Keying
HBM	Human Body Model
ISM	Industrial, Scientific, and Medical
IRQ	Interrupt Request
MCU	Microcontroller Unit
QFN	Quad Flat No-leads
RSSI	Received Signal Strength Indication
RF	Radio Frequency
Rx	Receive
Tx	Transmit

## Document Conventions

### Units of Measure

Table 7. Units of Measure

Symbol	Units of Measure
dB	decibel
dBc	decibel relative to carrier
dBm	decibel-milliwatt
°C	degree Celsius
Hz	hertz
KB	1024 bytes
Kbit	1024 bits
kHz	kilohertz
kΩ	kilohm
MHz	megahertz
MΩ	megaohm
μA	microampere
μs	microsecond
μV	microvolt
μVrms	microvolts root-mean-square
μW	microwatt
mA	milliampere
ms	millisecond
mV	millivolt
nA	nanoampere
ns	nanosecond
nV	nanovolt
Ω	ohm
pp	peak-to-peak
ppm	parts per million
ps	picosecond
V	volt

Document History Page

Description Title: CYRF6936, WirelessUSB™ LP 2.4 GHz Radio SoC Document Number: 38-16015				
Revision	ECN	Orig. of Change	Submission Date	Description of Change
**	307437	TGE	See ECN	New data sheet
*A	377574	TGE	See ECN	Preliminary release– <ul style="list-style-type: none"> <li>- updated Section 1.0 - Features</li> <li>- updated Section 2.0 - Applications</li> <li>- added Section 3.0 - Applications Support</li> <li>- updated Section 4.0 - Functional Descriptions</li> <li>- updated Section 5.0 - Pin Description</li> <li>- added Figure 5-1</li> <li>- updated Section 6.0 - Functional Overview</li> <li>- added Section 7.0 - Functional Block Overview</li> <li>- added Section 9.0 - Register Descriptions</li> <li>- updated Section 10.0 - Absolute Maximum Ratings</li> <li>- updated Section 11.0 - Operating Conditions</li> <li>- updated Section 12.0 - DC Characteristics</li> <li>- updated Section 13.0 - AC Characteristics</li> <li>- updated Section 14.0 - RF Characteristics</li> <li>- added Section 16.0 - Ordering Information</li> </ul>
*B	398756	TGE	See ECN	ES-10 update- <ul style="list-style-type: none"> <li>- changed part no.</li> <li>- updated Section 9.0 - Register Descriptions</li> <li>- updated Section 12.0 - DC Characteristics</li> <li>- updated Section 14.0 - RF Characteristics</li> </ul>
*C	412778	TGE	See ECN	ES-10 update- <ul style="list-style-type: none"> <li>- updated Section 4.0 - Functional Descriptions</li> <li>- updated Section 5.0 - Pin Descriptions</li> <li>- updated Section 6.0 - Functional Overview</li> <li>- updated Section 7.0 - Functional Block Overview</li> <li>- updated Section 9.0 - Register Descriptions</li> <li>- updated Section 10.0 - Absolute Maximum Ratings</li> <li>- updated Section 11.0 - Operating Conditions</li> <li>- updated Section 14.0 - RF Characteristics</li> </ul>
*D	435578	TGE	See ECN	<ul style="list-style-type: none"> <li>- updated Section 1.0 - Features</li> <li>- updated Section 5.0 - Pin Descriptions</li> <li>- updated Section 6.0 - Functional Overview</li> <li>- updated Section 7.0 - Functional Block Overview</li> <li>- updated Section 9.0 - Register Descriptions</li> <li>- added Section 10.0 - Recommended Radio Circuit Schematic</li> <li>- updated Section 11.0 - Absolute Maximum Ratings</li> <li>- updated Section 12.0 - Operating Conditions</li> <li>- updated Section 13.0 - DC Characteristics</li> <li>- updated Section 14.0 - AC Characteristics</li> <li>- updated Section 15.0 - RF Characteristics</li> </ul>
*E	460458	BOO	See ECN	Final data sheet - removed "Preliminary" notation

Document History Page (continued)

Description Title: CYRF6936, WirelessUSB™ LP 2.4 GHz Radio SoC Document Number: 38-16015				
Revision	ECN	Orig. of Change	Submission Date	Description of Change
*F	487261	TGE	See ECN	<ul style="list-style-type: none"> <li>- updated Section 1.0 - Features</li> <li>- updated Section 5.0 - Pin Descriptions</li> <li>- updated Section 6.0 - Functional Overview</li> <li>- updated Section 7.0 - Functional Block Overview</li> <li>- updated Section 8.0 - Application Example</li> <li>- updated Section 9.0 - Register Descriptions</li> <li>- updated Section 12.0 - DC Characteristics</li> <li>- updated Section 13.0 - AC Characteristics</li> <li>- updated Section 14.0 - RF Characteristics</li> <li>- added Section 15.0 - Typical Operating Characteristics</li> </ul>
*G	778236	OYR / ARI	See ECN	<ul style="list-style-type: none"> <li>- modified radio function register descriptions</li> <li>- changed L/D pin description</li> <li>- footnotes added</li> <li>- changed RST Capacitor from 0.1uF to 0.47 uF</li> <li>- updated Figure 9, Recommended Circuit for Systems</li> <li>- updated Table 3, Recommended bill of materials for systems</li> <li>- updated package diagram from ** to *A</li> </ul>
*H	2640987	VNY / OYR / TGE / AESA	02/20/2009	<ul style="list-style-type: none"> <li>- Removed range values in features description</li> <li>- Bit level register details removed and appended to the Wireless LP and PRoC TRM</li> <li>- updated register summary table 4</li> <li>- updated pin description diagram (figure 1)</li> <li>- updated the schematic of the radio (figure 10).</li> <li>- Removed Backward Compatibility section.</li> <li>- Removed Table 2</li> <li>- Updated RF table characteristics for Payload size</li> <li>- Added pkg diagram 001-12917</li> <li>- Updated BOM <a href="#">Table 3 on page 11</a>.</li> <li>- Updated <a href="#">Table on page 19</a> with Receiver information (T = 25°C, V<sub>CC</sub> = V<sub>BAT</sub> = 3.0 V, f<sub>OSC</sub> = 12.000000 MHz, BER &lt; 1E-3)</li> </ul>
*I	2673333	TGE / PYRS	03/13/2009	<ul style="list-style-type: none"> <li>Corrected <a href="#">Figure 9 on page 13</a></li> <li>Updated packaging and ordering information for 40 QFN (sawn) package</li> </ul>
*J	3232571	JCJC	04/18/2011	<ul style="list-style-type: none"> <li>Added section <a href="#">Receive Spurious Response on page 9</a>.</li> <li>Added note # 13 and referred in <a href="#">Table on page 19</a>.</li> <li>Updated template as per new Cypress standards.</li> <li>Added ordering code definitions, acronyms, and units of measure.</li> <li>Updated package diagrams:</li> <li>001-12917: *A to *C</li> <li>001-44328: *C to *D</li> </ul>
*K	4359286	DEJO	04/24/2014	<ul style="list-style-type: none"> <li>Updated <a href="#">Package Diagram</a>:</li> <li>spec 001-12917 – Changed revision from *C to *D.</li> <li>spec 001-44328 – Changed revision from *D to *F.</li> <li>Updated in new template.</li> <li>Completing Sunset Review.</li> </ul>

## Sales, Solutions, and Legal Information

### Worldwide Sales and Design Support

Cypress maintains a worldwide network of offices, solution centers, manufacturer's representatives, and distributors. To find the office closest to you, visit us at [Cypress Locations](#).

#### Products

<a href="#">Automotive</a>	<a href="#">cypress.com/go/automotive</a>
<a href="#">Clocks &amp; Buffers</a>	<a href="#">cypress.com/go/clocks</a>
<a href="#">Interface</a>	<a href="#">cypress.com/go/interface</a>
<a href="#">Lighting &amp; Power Control</a>	<a href="#">cypress.com/go/powerpsoc</a> <a href="#">cypress.com/go/plc</a>
<a href="#">Memory</a>	<a href="#">cypress.com/go/memory</a>
<a href="#">PSoC</a>	<a href="#">cypress.com/go/psoc</a>
<a href="#">Touch Sensing</a>	<a href="#">cypress.com/go/touch</a>
<a href="#">USB Controllers</a>	<a href="#">cypress.com/go/USB</a>
<a href="#">Wireless/RF</a>	<a href="#">cypress.com/go/wireless</a>

#### PSoC<sup>®</sup> Solutions

[psoc.cypress.com/solutions](#)  
[PSoC 1](#) | [PSoC 3](#) | [PSoC 4](#) | [PSoC 5LP](#)

#### Cypress Developer Community

[Community](#) | [Forums](#) | [Blogs](#) | [Video](#) | [Training](#)

#### Technical Support

[cypress.com/go/support](#)

---

© Cypress Semiconductor Corporation, 2005-2014. The information contained herein is subject to change without notice. Cypress Semiconductor Corporation assumes no responsibility for the use of any circuitry other than circuitry embodied in a Cypress product. Nor does it convey or imply any license under patent or other rights. Cypress products are not warranted nor intended to be used for medical, life support, life saving, critical control or safety applications, unless pursuant to an express written agreement with Cypress. Furthermore, Cypress does not authorize its products for use as critical components in life-support systems where a malfunction or failure may reasonably be expected to result in significant injury to the user. The inclusion of Cypress products in life-support systems application implies that the manufacturer assumes all risk of such use and in doing so indemnifies Cypress against all charges.

Any Source Code (software and/or firmware) is owned by Cypress Semiconductor Corporation (Cypress) and is protected by and subject to worldwide patent protection (United States and foreign), United States copyright laws and international treaty provisions. Cypress hereby grants to licensee a personal, non-exclusive, non-transferable license to copy, use, modify, create derivative works of, and compile the Cypress Source Code and derivative works for the sole purpose of creating custom software and or firmware in support of licensee product to be used only in conjunction with a Cypress integrated circuit as specified in the applicable agreement. Any reproduction, modification, translation, compilation, or representation of this Source Code except as specified above is prohibited without the express written permission of Cypress.

Disclaimer: CYPRESS MAKES NO WARRANTY OF ANY KIND, EXPRESS OR IMPLIED, WITH REGARD TO THIS MATERIAL, INCLUDING, BUT NOT LIMITED TO, THE IMPLIED WARRANTIES OF MERCHANTABILITY AND FITNESS FOR A PARTICULAR PURPOSE. Cypress reserves the right to make changes without further notice to the materials described herein. Cypress does not assume any liability arising out of the application or use of any product or circuit described herein. Cypress does not authorize its products for use as critical components in life-support systems where a malfunction or failure may reasonably be expected to result in significant injury to the user. The inclusion of Cypress' product in a life-support systems application implies that the manufacturer assumes all risk of such use and in doing so indemnifies Cypress against all charges.

Use may be limited by and subject to the applicable Cypress software license agreement.